

# K500+

## Kodiak<sup>®</sup> Plus Cone Crusher



### Crusher

- High-efficiency roller bearing design
- Remote Close Side Setting (CSS) adjustment
  - Digital readout setting control
  - Patented "gall resistant" brass bowl threads
  - Patented "no creep" bowl clamp
- Patented mechanical "crusher duty" cone brake
  - K200+, K300+, K350+, K400+
- Hydraulic cone brake std on K500+
- Patented liner retention assembly
  - Low impact Tramp Iron Relief (TIR) system
  - Pressure relief valves
  - Large bore heavy-duty relief cylinders
  - Hydraulic "one button" chamber clearing
- Bronze field-replaceable V-Seat liners
- Permanently precision balanced
- Protected internal counterweights
- Baseframe tub liners field-replaceable 400BHN
- Cold climate oil recirculation
- Manganese liners (select from list of interchangeable liners)
- Crusher tools
- Operation and Maintenance manuals
- Crusher feed hopper
- Bowl float monitoring

### Hydraulic Power Unit

- Reservoir (filled at the factory)
- 15HP (11kW) TEFC motor
- 6 gpm (23Lpm)
- Remote control panel w/ 50' cable

### Oil Cooler

- 1 hp (.75kW) TEFC motor (K200+, K300+, K350+, K400+)
- 3 hp (2.24kW) TEFC motor (K500+)

### Lube Assembly

- 3hp (2.2kW) TEFC motor
- 2 x 1500W heaters
- Automatic oil cooler bypass
- Oil flow sensor

### Kodiak<sup>®</sup> Control System

- Auto control of crusher lube functions
- Auto control of crusher hydraulic functions
- Interlocked lube/hydraulic protection
- Integration with existing plant controls
- Feed hopper monitor
- Cold weather overnight oil circulation
- Assistance for specialized maintenance
- Assistance for specialized adjustments
- Diagnostics
- Bowl float monitor
- Liner wear monitoring
- Color display

### Crusher Options

- V-Belt drive
- Cogged belt drive
- Longer remote cables (100', 150', 200')
- Hopper extension with overflow chute
- Hydraulic cone brake (K200+, K300+, K350+, K400+)
- Kidney loop auxiliary lube filtration
- Electric motor(s)

	K200+	K300+	K350+	K400+	K500+
A	79.875in (2,029mm)	83.125in (2,111mm)	85.625in (2,174.875mm)	90.25in (2,292mm)	96.688in (24,56mm)
B	73.875in (1,876mm)	77.75in (1,975mm)	80.375in (2,041.525mm)	85.125in (2,162mm)	90.188in (2,291mm)
C	65.5in (1,664mm)	68.25in (1,734mm)	71in (1,803.4mm)	75.375in (1,915mm)	78.438in (1,992mm)
D	40.313in (1,024mm)	41in (1,041mm)	44.625in (1,133.475mm)	46.25in (1,175mm)	51in (1,295mm)
E	53.52in (1,359mm)	56.52in (1,436mm)	56.75in (1,441.45mm)	62.125in (1,578mm)	68.875in (1,749mm)
F	75.375in (1,915mm)	79.75in (2,026mm)	82.375in (2,092.325mm)	85.25in (2,165mm)	93.938in (2,386mm)
G	38.875in (987mm)	42in (1,067mm)	44.625in (1,133.475mm)	44.5in (1,130mm)	49.5in (1,257mm)
H	77.5in (1,969mm)	84in (2134mm)	84in (2,133.6mm)	89in (2261mm)	97.5in (2,476mm)
I	38.875in (987mm)	42in (1,067mm)	44.625in (1,133.475mm)	44in (1,130mm)	48.75in (1,238mm)
J	42in (1,067mm)	46in (1,168mm)	46in (1,168.4mm)	46.25in (1,175mm)	50.8in (1,473mm)
L	42in (1,067mm)	46in (1,168mm)	46in (1,168.4mm)	46.25in (1,175mm)	50.8in (1,473mm)
M	26in (660mm)	27.5in (699mm)	27.5in (698.5mm)	29.5in (749mm)	32.5in (825.5mm)
N	63.25in (1,607mm)	69.5in (1,765mm)	69in (1,752.6mm)	74in (1,880mm)	81.5in (2,070.1mm)
O	26in (660mm)	27.5in (699mm)	27.5in (698.5mm)	29.5in (749mm)	32.5in (825.5mm)
P	52in (1,321mm)	55in (1,397mm)	55in (1,397mm)	59in (1,499mm)	65in (1,651mm)

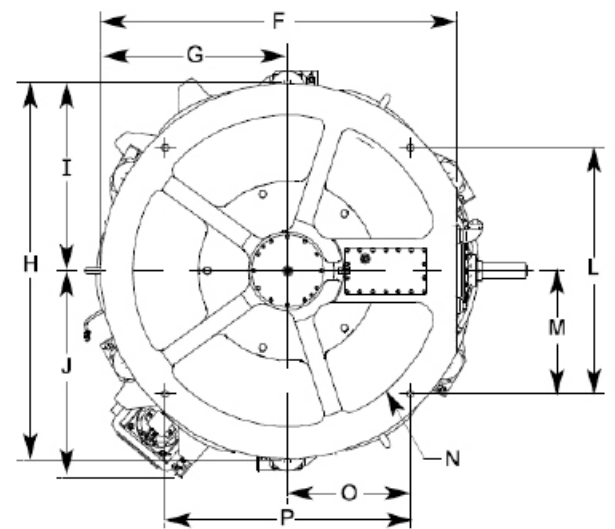
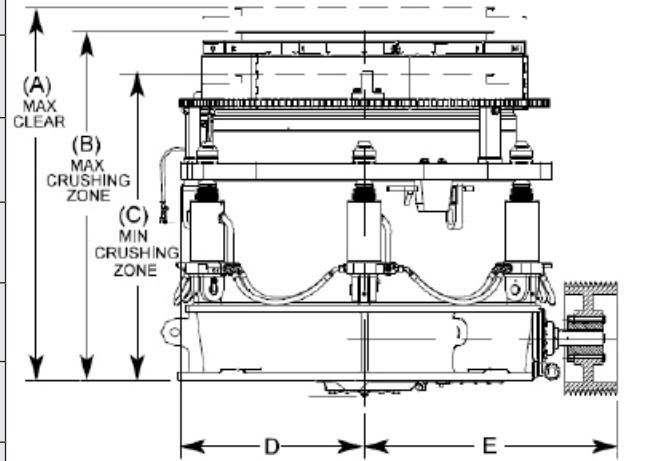

**BOTTOM VIEW**

	K200+	K300+	K350+	K400+	K500+
Head Diameter	40in (1,016mm)	45in (1,143mm)	48in (1,219mm)	54in (1,372mm)	60in (1,524mm)
Operating Range	800 – 950 RPM	800 – 950 RPM	750 - 950 RPM	800 – 950 RPM	750 – 850 RPM
Horsepower	200 (150 kW)	300 (225 kW)	350 (261 kW)	400 (300 kW)	500 (373 kW)
Total Weight	35,000lb (15,875kg)	42,375lb (19,221kg)	47,975lb (21,761kg)	57,875lb (26,251kg)	77,000lb (34,927kg)
Upper Assembly With Liner	13,500lb (6,123kg)	17,225lb (7,813kg)	17,500lb (7,938kg)	20,225lb (9,174kg)	28,000lb (12,701kg)
Lower Assembly With Mantle & Sheave	21,500lb (9,752kg)	25,150lb (11,408kg)	28,000lb (12,701kg)	37,650lb (17,077kg)	49,000lb (22,226kg)